

SELECTION

In order to further reduce the number of eggs with light jumps (e.g. due to transfer from the longitudinal belt to the curve conveyor), the cross bars of the conveyor chain can be coated with plastic. This plastic coating increases the damping effect of the chain and improves protection for the egg in extreme climate conditions. This conveyor chain version is available in widths of 350, 500 und 750 mm.

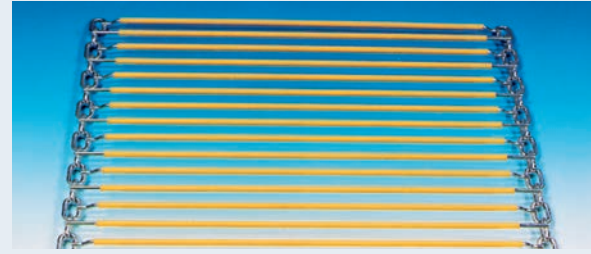

VERSIONS

System widths

The width of the curve conveyor determines the conveying rate. At a speed of 7 m/min. the following values result:

Width	Conveying rate
200 mm	15.000 Eggs/h
250 mm	20.000 Eggs/h
350 mm	30.000 Eggs/h
500 mm	45.000 Eggs/h
750 mm	65.000 Eggs/h

The required height is achieved by means of height-adjustable floor supports. Several versions are available which can be used universally.

For safety reasons, the conveyor chain is covered on both sides with a red protective profile.

A telescopic unit is required to connect the conveyor to an egg lift. This is designed with a balancing unit and articulated elements on both sides and can be inserted into the curved conveyor system at any point. The length depends on the given battery height and is produced individually.

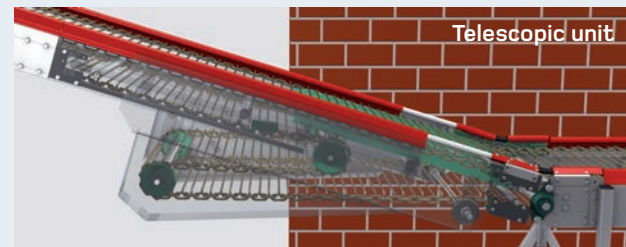

Conveyor width	Ri	Rm	Ra
200 mm	420	540	660
250 mm	530	675	820
350 mm	750	945	1140
500 mm	1080	1350	1620
750 mm	1630	2025	2420

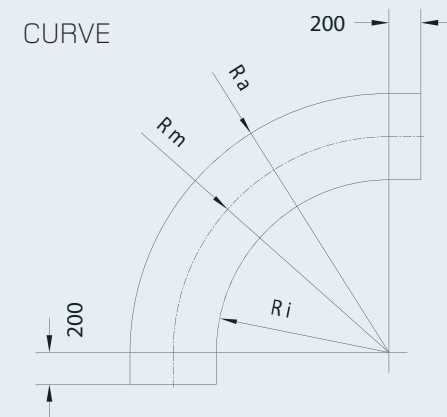

Driving units

The choice of the right drive is based on the conveying lengths, taking into account height differences and the number of curves.

The individual engagement positions of the drives are calculated individually for each project as part of the project planning.

Therefore, we recommend that you request a design for each project. This ensures the selection of the correct drive positions and thus ensures smooth operation of the conveyor system for a long time.

LUBING

CURVE CONVEYOR FOR EGG TRANSPORT



SUITABLE COMPLEMENT



Cleaning Unit

Input Unit

Egg Counter EMEC

LUBING

LUBING Maschinenfabrik GmbH & Co. KG

Lubingstraße 6 · 49406 Barnstorf

+49(0)54 42 - 98 79-0

+49(0)54 42 - 98 79-33

www.lubing.com · info@lubing.com

LUBING CURVE CONVEYOR FOR EGG TRANSPORT

The conveyor system is of crucial importance for egg farms of all sizes. Many years of practical application experience with LUBING Conveyor-Systems confirm our leading position worldwide.

Due to the different house arrangements, a tailor-made individual solution is usually required.

We will be pleased to provide you with an individual design for the optimum Conveyor-System to meet your requirements.

The central element of the curve conveyor: The conveyor chain

The conveyor chain runs on a high-strength plastic sliding profile. It consists of two hardened outer chains with welded-on rods. The rods are arranged in one plane at the standard chain to make the transfer to the conveyor chain smooth and direct and to avoid crushed of the eggs in the inner curve.

The straight conveyor section of the curve conveyor is composed of connecting elements which are 1 m, 2 m or 3 m long.



The side profiles and the cross-struts are made of anodized aluminum. All plastic sliding profiles and guide elements are wear-resistant and can be replaced in the existing system if necessary.

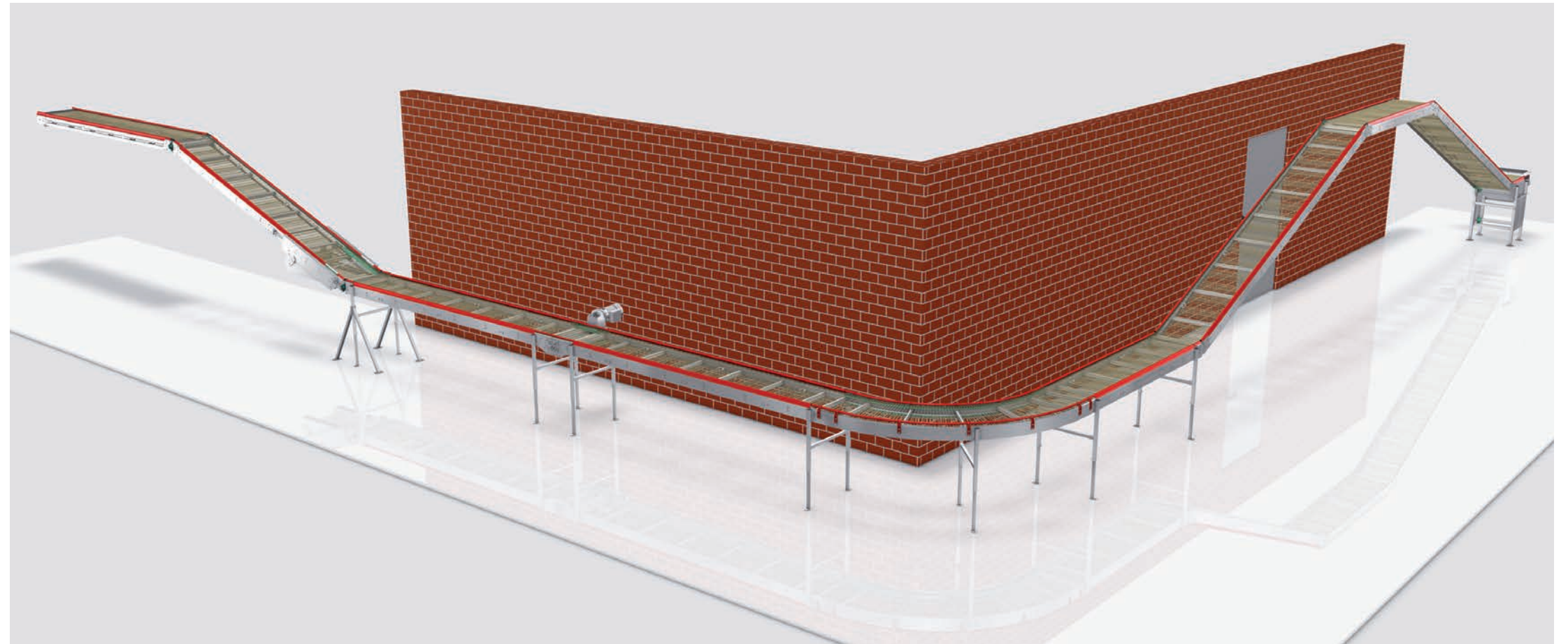

Please refer to the separately available → Overview „Conveyor Chains“ to determine the possible incline/decline of the respective chains.



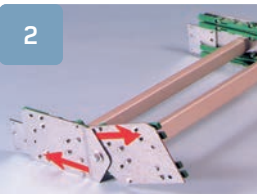
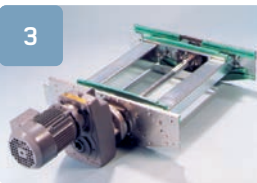

ADVANTAGES OF THE LUBING CURVE CONVEYOR

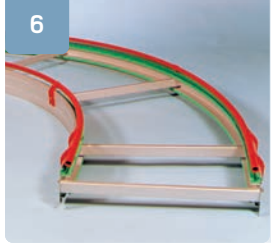
- highest functional reliability with minimum maintenance requirements
- a unit construction system with elements designed to cope with any imaginable spot requirements, all kinds of curves, large differences in height and distances
- conveying widths from 200 mm to 750 mm.
- conveying capacities from 15,000 eggs/h to 65,000 eggs/h
- optimum rentability

1	End pieces
	<ul style="list-style-type: none"> • simple and safe deflection of the conveyor chain at the end via guide rollers
2	Pivoting unit
	<ul style="list-style-type: none"> • enables inclines or declines in the conveyor system • infinitely adjustable for inclines and declines
3	Intermediate drive
	<ul style="list-style-type: none"> • for conveyors over approx. 50 m • for large plants several intermediate drives can be used
4	Connecting element
	<ul style="list-style-type: none"> • available in closed and laterally open version • the open sections are used at transfers with dirt collection plates

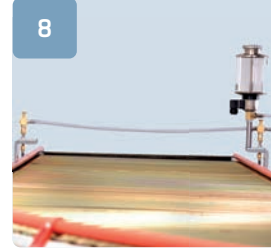
5	Front drive
	<ul style="list-style-type: none"> • Main drive for the conveyor chain • with integrated tensioning element for correct chain tensioning
6	Bend
	<ul style="list-style-type: none"> • standard designs in 180°, 90°, and 45° bends • on request production of bends in all conceivable degrees
7	Guide unit
	<ul style="list-style-type: none"> • for optimal distribution of eggs on the conveyor chain • creates space for additional eggs in case of further transfers

8	Electric drip oiler
	<ul style="list-style-type: none"> • regularly provides the outer chain links of the conveyor chain with a life-extending oil film • Manual lubrication is no longer required
9	Multiple drive
	<ul style="list-style-type: none"> • specially designed for multitier systems • one motor with one main drive shaft drives several conveyor lines simultaneously

LUBING

Further information under WWW.LUBING.COM